



Ambient Timber Windows & Doors The Sound of Silence

Restore peace and quiet in your home and protect your health and wellbeing with a range of certified noise reducing timber windows and doors.

SILENCE IS A PLACE OF GREAT POWER AND HEALING

Rachel Naomi Remen

#Soundofsilence

In an age of noise, it has become increasingly hard to find the silence we crave. Both our body and mind require the time to restore and escape the chaos of everyday life and this can only take place in a calm, relaxed and peaceful space. A life full of noise is a life without relief or space to simply be. Our homes should provide this relief and be a haven to relax and find peace.

We explore the problem with noise and the effects that this has on the body and mind. We will talk you through sound reducing solutions and the benefits of each and by introducing our Ambient Timber Window and Door range we will show you how to find silence in a noisy world. Dedicated to helping you design healthy, happy homes we guide you through choosing a noise reducing solution, which is right for you and your home.



CONTENTS

The Problem with Noise

- 04 Noise and Health
- 06 What is Noise Pollution?
- 07 Environmental Noise
- 08 Noise and Buildings
- 10 How do I Reduce Noise?

The Sound of Silence

- 12 Ambient Windows & Doors
- 14 How Ambient Windows & Doors Work
- 16 Choose your Sound Reduction Rating
- 18 The Ambience of Sliding Sash Windows
- 20 Why Choose a Certified Solution?
- 21 5 Step Purchasing Guide

Designing out Noise

- 22 Silence and the City
- 25 Suburban Silence
- 27 Projects
- 28 Noise Reduction in New Homes
- 29 Helping you Design out Noise
- 30 FAQ's



NOISE AND HEALTH

Noise is derived from the Latin word 'nausea', meaning sickness.

It is said that the word 'noise' in fact stemmed from unpleasant sounds or complaints made by seasick passengers or sailors. It is no coincidence then to find that noise actually does have the capacity to make us sick.

54%
of the UK population is exposed to daytime noise pollution which is greater than the recommended levels and given the latest research surrounding the health impacts this is increasingly concerning.¹



In 2011, the World Health Organisation (WHO) released a report titled 'Burden of disease from environmental noise' which, collated over a ten year period, assessed the health effects of a range of environmental noises. The study concluded that at least **one million** healthy years of life are lost each year in Europe alone due to noise pollution.

This is a problem which can cause a variety of health problems, affecting the heart, brain and nervous system, and perhaps even more worryingly so, is getting worse. The study notes that while other forms of pollution are decreasing, noise pollution is increasing and not only this, we are becoming more sensitive to this noise.

The reason for this could be perhaps put down to stress and the prevalence of this in modern society. Stress is a widespread issue and has been shown to affect 85% of UK adults.

A study undertaken by scientists at the Karolinska Institute and Stockholm University's Stress Research Institute found that exposure to acute stress can increase hypersensitivity to sound. Some women in the study experienced hearing sound at 60dB (the level of a normal conversation) as a noise so loud that it was uncomfortable to them.

In today's fast paced society, this is particularly concerning.

1 million healthy years of life are lost each year in Europe.

3 in 100
deaths in the UK are caused by exposure to noise.¹



Traffic noise has been linked to health issues such as cardiovascular disease, heart attack and dementia. A study published in The Lancet found that those who live closest to major traffic routes are up to 12% more likely to be diagnosed with dementia.⁴

1 in 5
exposed to noise at night could be significantly damaging their health.²



Those that live near airports are at a more increased risk with studies published in the British Medical Journal showing that people living in areas exposed to the highest noise levels had a 10-20% higher risk of heart and stroke-related deaths.⁵

Thousands
of people in Britain may be dying because of a lack of peace and quiet.³

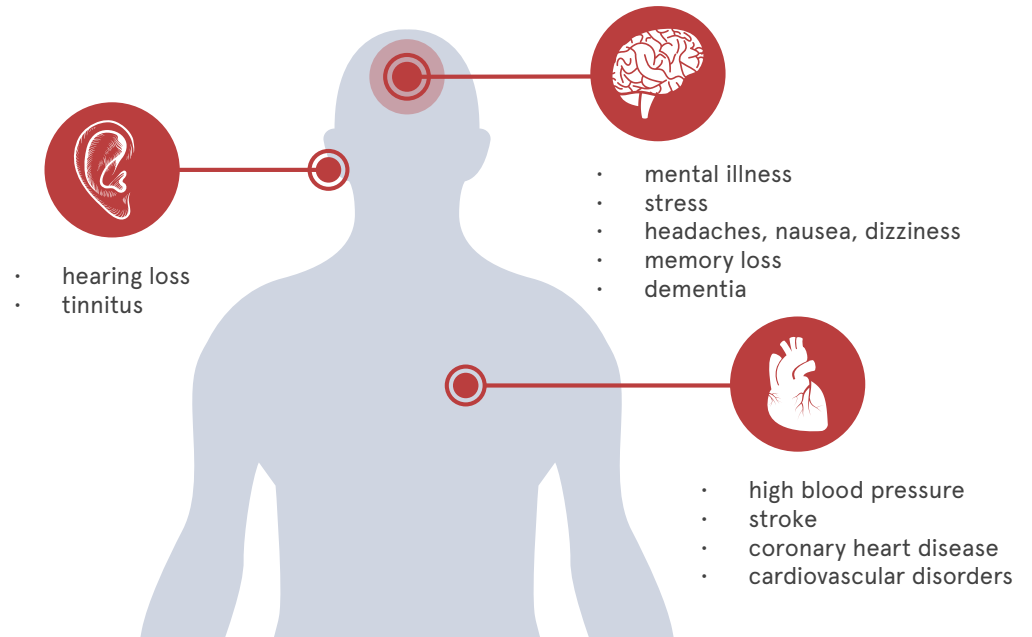

1. BRE, (2000,2001) *The National Noise Incidence Study (United Kingdom)*.
 2. World Health Organisation (WHO), (2009). *Night noise guidelines for Europe*.
 3. World Health Organisation (WHO), (2011). *Burden of disease from environmental noise. Quantification of healthy life years lost in Europe*.
 4. Hong Chen, (Jan 2017). *Living near major roads amnd the incidence of dementia, Parkinsons disease and multiple sclerosis*.
 5. BMJ, (2013). *Aircraft noise and cardiovascular disease near Heathrow airport in London*.



WHAT IS NOISE POLLUTION?

To answer this question we first need to explore the difference between sound and noise. Sound is a form of energy that is transmitted by pressure variations which the human ear can detect. When one plays a guitar, the vibrating chords set air particles into vibration and generate pressure waves in the air.

Noise, on the other hand is an unwanted sound and one that causes disturbance. Noise is defined as an irregular, fluctuating wave pattern that is loud or unpleasant and causes discomfort or irritation.

Sound is an important and valuable part of everyday life. But when sound becomes noise, it can negatively affect our mental and physical health. This type of noise pollution is a serious threat to our quality of life, health, wellbeing and perhaps even more worryingly so, is on the rise.



Measuring Noise

The perceived loudness of sound is measured in decibels, often abbreviated to dB. The dB scale starts at the threshold of audibility with 0dB and even at this level noise can be perceived by the human ear.



ENVIRONMENTAL NOISE

In modern life, we are subjected to various types of environmental noise on a daily basis and the situation is getting worse. We examine the common types of disturbance and the noise rating at which they take place.



Despite the commonality of traffic noise, this has been identified by the World Health Organisation as ranking second amongst all environmental threats to public health.



Ranging from 90-135dB those in proximity to a flight path are at serious risk. Many studies have found aircraft noise is linked to stress, hypertension and sleep disturbance.



With train noise being measured at around 90 dB, excessive exposure to railway noise pollution has been proven to increase your chances of developing cardiovascular disease, poor sleep and diminished productivity.



Whether this is noisy neighbours or a crowded high street, anti-social noise is a growing issue and exposure can increase hypertension leading to cardiovascular disorders.

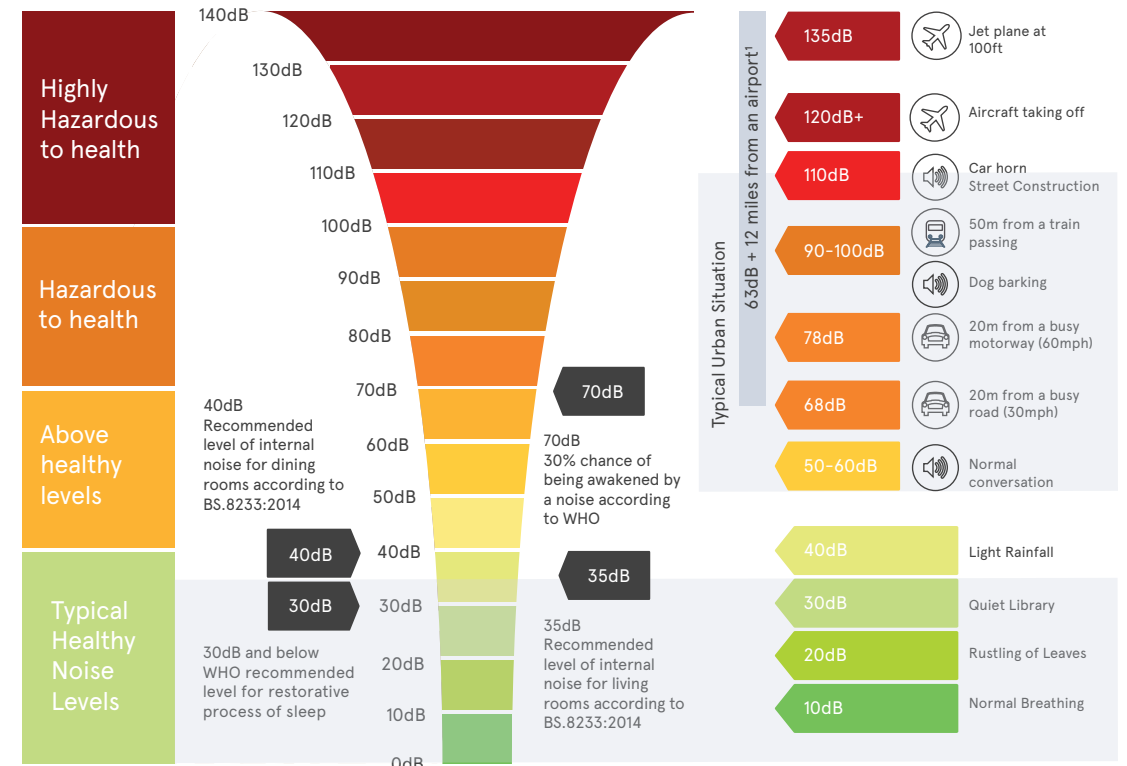

1. BMJ, (2013). Aircraft noise and cardiovascular disease near Heathrow airport in London. The above noise levels are approximate and should only be used as a guide.





NOISE AND BUILDINGS

Noise will enter a building through the weakest point and the acoustic performance of the whole building will be affected considerably by the weakest part of the building fabric.

Take a typical Victorian terrace in an urban area. The main fabric of the building itself (i.e. the walls) will be around 50–60dB. The windows, typically single glazed sliding sash windows (which are notoriously draughty), will measure at around 10–15dB. The windows will most likely take up around 70% of the fabric meaning that they are key to the acoustic performance of the home. If you were to strengthen the acoustic performance of walls by such methods as adding insulating plasterboard, sound reduction curtains and blinds, unless you have dealt with the windows and doors this will have very little to no effect as noise will still escape through this weak point regardless.

“Noise pollution can be a big threat to our health. It is therefore imperative we treat this problem with the importance it needs.”

Simon Beer
Bluesky Certification



Simon Beer of Bluesky Certification discusses the importance of noise reduction and why testing the whole window is crucial.

What are the most crucial aspects of a building fabric that affect noise?

The methods of construction that have been used in the UK over the past few decades mean that the main building fabric will normally already have a good acoustic performance. Weak points include air bricks (which can be easily dealt with), the roof (which can be dealt with by loft insulation/upgrading the ceiling plasterboard) and the windows and doors.

Most windows and doors will have an acoustic performance that is substantially worse than the main building fabric, so improving these is likely to result in a substantial reduction in the external noise that enters the building.

Why are windows seen as the weakest point?

Sound will enter a building through its weakest point and this typically is the windows. A weakly performing window will severely negate the effect of even the strongest wall. A typical single glazed sliding sash window has little or no ability to act as a defence barrier for outside noise. If you are looking to soundproof your home your first port of call is to assess the windows.

If windows and doors are so important, why is their acoustic performance often overlooked?

A properly installed acoustic window or door will make a huge improvement to the internal environment. Despite this, many manufacturers do not offer a noise reducing solution and when they do you cannot always rely on the noise reduction levels stated. Installing a certified noise reducing window ensures a proven level that has been proven to reduce noise.





Myth:
Triple glazing reduces sound

"There is a common misconception that triple glazing provides better sound insulation than double glazing. However, manufacturer's test data (for the glass alone) shows that the reduction for traffic noise for a similar configuration of double and triple glazed panes is typically similar, or can even be lower. It is certainly worth avoiding configurations with matched panes, as they share a dip in performance at the same frequencies, and so allow sound to pass through more effectively. Using different pane thicknesses can help overcome this problem. Small differences in air gaps between 12 and 16 mm generally only have a small effect on performance and is generally disregarded."

Jack Harvie-Clark, Apex Acoustics

HOW DO I REDUCE NOISE?

There are various options that can help combat the problem of noise pollution; the most common being secondary glazing, acoustic glass and sound reduction windows. One of the common considerations here is should I repair or replace? In order to make an informed decision and ensure you are spending your money wisely you should consider the benefits of each.

	Pros	Cons
<p>Curtains and Blinds</p> <p>There are claims that by using thicker curtains or blinds you can soundproof your room. However, the structure of the fabric still allows for sound to escape rendering them ineffective.</p> <p>Cost: £ Performance: ★ Appearance: ★</p>	<ul style="list-style-type: none"> ✓ Cheaper than most other options 	<ul style="list-style-type: none"> ✗ Offers very little sound reduction ✗ The majority do not reduce noise entering from outside
<p>Secondary Glazing</p> <p>This is a solution that aims to repair the problem as opposed to resolving it. Despite providing good sound reduction due to the large air gap between the glass and the existing window, the end result can be unsightly</p> <p>Cost: ££ Performance: ★★ Appearance: ★</p>	<ul style="list-style-type: none"> ✓ Can be cost effective ✓ Can provide good noise reduction 	<ul style="list-style-type: none"> ✗ Must be installed 150-200mm from window to be effective ✗ Difficulties opening window ✗ Poor security levels ✗ Unsightly
<p>Replacement Acoustic Glass</p> <p>Acoustic glass is effective in reducing noise, however due to the unit thickness replacing single glazing with acoustic glazing is simply not a viable option.</p> <p>Cost: £££ Performance: ★ Appearance: ★★</p>	<ul style="list-style-type: none"> ✓ Where viable acoustic glazing does provide good noise reduction 	<ul style="list-style-type: none"> ✗ Installing acoustic glazing into a frame that is draughty will have little or no effect.
<p>Noise Reducing Windows</p> <p>Replacing your windows is by far the most effective solution not only in terms of the noise reductions you will experience but in terms of home security and thermal efficiency. Not only this, you can completely restyle your home and add value.</p> <p>Cost: ££££ Performance: ★★★★★ Appearance: ★★★★★</p>	<ul style="list-style-type: none"> ✓ The most effective noise reducing solution ✓ Upgraded security levels in the home ✓ Adds value ✓ Improved thermal efficiency ✓ Improved weather performance 	<ul style="list-style-type: none"> ✗ The most costly solution ✗ Some disruption whilst windows are replaced





AMBIENT WINDOWS & DOORS

The Sound of Silence

Imagine creating a space where you can truly escape. This space should be a place of wellbeing and calm. A place to relax and restore. Whether you are a homeowner looking to make your family home a haven, a house builder or developer building close to a main road, flight path or railway with strict planning restrictions, we have a noise reducing solution to suit you; one which will give you complete assurance of the level of noise reduction you will experience and the resulting health and wellbeing benefits.

WHY CHOOSE AMBIENT WINDOWS?



42dB Noise Reduction

Whether positioned on a busy high street or an airport, with an overall window dB rating of up to 42dB you will find a solution to restore your very own sound of silence.



Bluesky Certified

Unique in that we have certified the window as a whole you have complete assurance that the dB rating we are stating is the sound reduction you will experience.



A-Rated Noise Reduction

We have achieved a Bluesky certified A-rated noise reduction level which will help you create a home of calm and tranquility in which you can be truly safe and sound.



Safe and Sound

Acoustic glass security ratings of P2 and P4 as standard surpasses the P1A required for Secured by Design and Part Q of the Building Regulations, keeping your home both soundproof and secure.



Thermally Efficient

With whole window u values as low as 1.2 W/m²K, 40% better than current LB1 Building Regulations you can rest assured that your home is not only safe and sound but warm and cosy.



Weatherproof

Weatherproofing and soundproofing go hand in hand and as such all products are tested to perform against all weather conditions with sliding sash windows tested to perform against winds of 136mph.





Rediscover the **sound of silence**

HOW AMBIENT WINDOWS AND DOORS WORK

Bereco Ambient timber windows and doors offer a level of noise reduction assurance which is unparalleled. Being the only timber window solution to be certified by a third party scheme, you can be completely assured of the level of noise reduction you will experience. Ambient timber windows work by absorbing the sound wave and causing it to lose power. Each element of both frame and glass has been carefully designed to absorb and reflect pressure to offer optimal noise reducing properties.

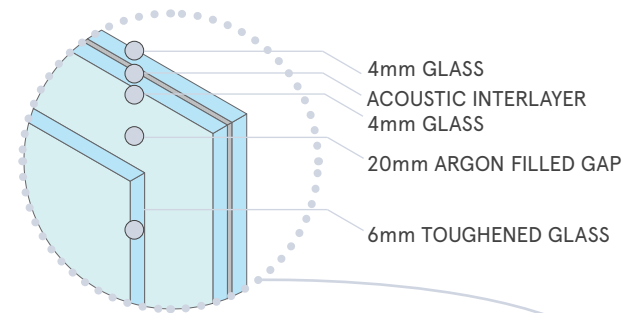

Acoustic Glass

Acoustic glass consists of two panes which have been laminated together using an acoustic membrane. Aside from bonding these two panes together, this works to absorb the sound energy and prevent vibration travelling through the glass.

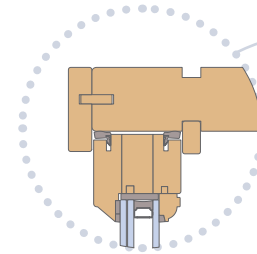

Dual Weatherstrip

Where air leaks through so does sound. Making use of insulating double weatherstrip not only has benefits in terms of reduced air leakage and weatherproofing but has the advantage of increased acoustic performance.

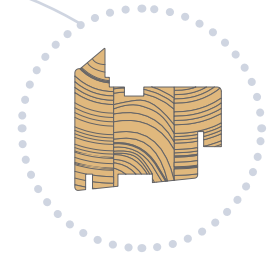

Engineered Timber

The ultimate renewable material, wood is one of the oldest and most attractive but that's not the only benefit; as a natural material, it also has a stronger sound dampening property than most other frame materials.

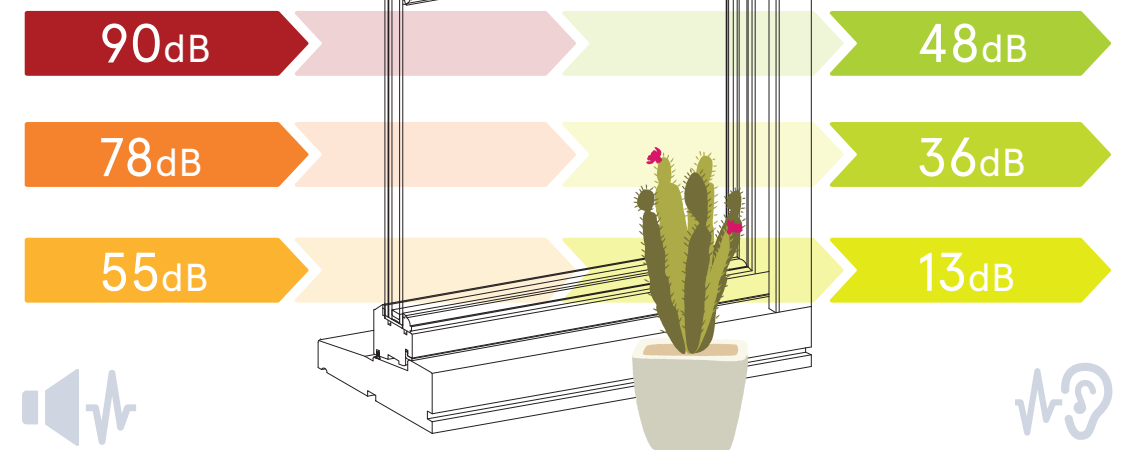

CHOOSE YOUR SOUND REDUCTION RATING

Once you have identified the noise you may be experiencing, you will then want to select the most effective sound reduction rating for you and your home. As each and every home is unique and the noise that we each experience can vary in both proximity and frequency, we have designed a range to offer a solution for each unique environment. If you are unsure of the level of noise in your home, refer to our handy guide on page 7.

STANDARD UK DOUBLE GLAZED WINDOW	BERECO DOUBLE GLAZED WINDOW				AMBIENT RANGE
22 dB	33 dB	38 dB	41 dB	42 dB	
Bluesky Noise Rating					
None	C	B	A	A	
Weighted Sound Reduction Whole Window, R _w (C:Ctr)					
22dB	33(-1; -5)dB	38(-1; -4)dB	41(-1; -6)dB	42(-1; -5)dB	
Glazing Acoustic Rating, R _w (C:Ctr)					
23dB	31dB	39dB	42dB	46dB	
Unit Configuration					
4/16Ar/4	4/16Ar/4ESGT	8.8/12Ar/4ESGT	8.8/20Ar/6ESGT	8.8/16Ar/9.5T	
Centre Pane U Value (U _g) (Wm ² K)					
1.0	1.0	1.0	1.0	1.0	

Sound Reduction Indices for Each Octave Band

Hz	Measured Performance Average (dB)				
125	**	25	30	30	28
250	**	19	26	32	37
500	**	28	35	40	41
1000	**	36	41	42	42
2000	**	42	46	43	45
4000	**	40	45	47	51

*Test data relates to vertical sliding sash timber window
 **42dB available with Traditional beading only.



The dB ratings ranging from 33dB right up to 42dB represent the overall R_w rating for the whole window taking into account both frame, seals and glass. This rating represents the overall sound reduction.

Reduce road noise to a quiet whisper

Any bedroom with a single glazed window overlooking a road in a busy town will be experiencing internal noise levels of about 50dB. If you opt for our 33dB window you would bring this down to only 22dB*, almost the rustling of leaves.

Restore your Sleep

If you are living in a Victorian terrace which is subject to road noise of 68dB, a 42dB window will take this down to 31dB* which is the equivalent of a quiet library and 12% better than the level the World Health Organisation recommends to for a healthy living space (35dB).

*Values take into account the Ctr correction which relates to traffic noise.

We want to help you find the solution that suits you, so if you are looking for advice on how to restore your own sound of silence contact us today on:

01709 838 188.

NOISE RATING

MANUFACTURER: Bereco Ltd.
 PRODUCT NAME: Vertical Sliding Sash Timber Window
 SCOPE REFERENCE: NRW-0172

Sound Reduction Value (R _w): (BS EN 10140 - 2)	42 dB
Correction for traffic and low frequency (Ctr):	-5 dB

Frequency (Hz):	125	250	500	1000	2000	4000
Measured performance:	27.5	36.5	41.1	42.2	44.9	50.7

This Bluesky Noise Rating must be read in conjunction with the scope of certification that is referenced above and does not guarantee the performance of individual products. Visit www.blueskyert.com for further details.

BLUESKY CERTIFICATION

As part of the Bluesky certification for Noise Reducing Windows each window is awarded a rating between A++ and E. Based on a sound dial, as what you are experiencing can be likened to turning down the volume, both the 42dB and 41dB have achieved an A rating.

The majority of windows and doors on the market would achieve a C, D or E rating. Fitting an A-rated product will greatly reduce noise levels in the building compared to a standard window and will be sufficient for almost all cases.





Make your home your
CALM PLACE

32%
better
noise reduction
than UK average

THE AMBIENCE OF SLIDING SASH WINDOWS

A staple of the Victorian era, sliding sash windows are one of the most notoriously drafty windows, hence are known to offer a lesser performance when it comes to noise reduction. Our sliding sash windows offer excellent draughtproofing tested to perform against winds of 136mph.

Due to the perception of sliding sash windows we decided to put this particular window through acoustic testing and as part of the Ambient Range, this has achieved an overall window noise reduction rating of 42dB and a Bluesky A-rating.

Both our traditional and contemporary sliding sash in the standard range has been tested to achieve a window rating of 33dB which is 32% better than the UK average.



“Being positioned facing a busy road in central Wimbledon in order to build a comfortable family home we needed to address the noise reducing efficiency of the windows. Bereco’s 33dB sliding sash was perfect in that we had the assurance that this would provide a living space of calm in which the clients can relax seated in the large front facing bay window.”

Martin Down, Indigo Projects





5 STEP PURCHASING GUIDE

1 Determine your environmental noise level

An acoustic specialist will be able to provide a full report of the noise levels in your home but as this can be costly this is usually produced for new homes and developments. If you want to have some idea of the level of noise in your home there are apps available that will measure this. For a guide, refer to page 7 which will give you an idea of the level of noise you may be experiencing and whether or not this can be considered harmful to your health.

2 Identify the dB rating which provides the appropriate sound reduction

Once you have determined the noise level in your home, you can select the sound reduction rating that you wish to achieve. Our A-rated window will provide a sound reduction that will be suitable for almost all levels of noise.

3 Check whether the dB rating refers to glass or overall window or door

Most manufacturers will state the dB rating for the glazing alone but this does not take into account the noise 'leak' that may potentially occur through the frame. Poorly fitted gaskets, gaps in the frame and trickle vents can all be responsible for this. At Bereco we have measured the overall dB rating for the window and this is what we state. We recommend that ventilation is achieved via alternative methods as opposed to trickle vents as this is another weak point through which noise can leak.

4 Does the manufacturer have test data available?

If you are presented with a test report, you should also verify that the specification tested is the same as what is to be supplied. The easiest way to have the assurance that this is the case is to ask if the product has been certified in addition to being tested.

5 Check for third-party certification

Ideally, the manufacturer should have third-party certification covering the acoustic performance of the product. This simplifies the process of checking the manufacturer as it gives independent verification through factory inspections and audit tests that the product has the expected performance. If you are presented with a statement claiming 'tested to...' you should always ask if the product is certified by a third-party.

WHY CHOOSE A CERTIFIED SOLUTION?

There are many sound reduction solutions which are sold on the premise that they are 'tested to certain dB ratings.' Many people can mistake 'tested' for 'certified' and in which case are at risk of purchasing an inferior solution. Third-party certification is important as this simplifies the process of checking the manufacturer as it gives independent verification through factory inspections and audit tests that the product has the expected performance.

Bereco Ambient Windows have achieved certification to Bluesky Noise Reducing Windows. Only those who have joined the Bluesky Certification Noise Reducing Windows scheme are eligible to use this label, to give the confidence that the products have been independently verified by an expert in windows and doors.



Project:
Old Brompton Road

Location:
London, UK

Area: 1,300sqm

SILENCE AND THE CITY

This luxury development featuring 11 architecturally designed apartments above a large retail unit demands a prominent corner location in central Kensington. Situated on one of London's red routes, the build has been carefully designed to create a luxury haven of silence and calm to escape the sound of the city.

Old Brompton Road starts from South Kensington Underground station and runs south-west, through a mainly residential area, until it reaches West Brompton and the area around Earl's Court tube station. The road is one of London's red routes that form a network of major roads which make up 5% of the city's roads, but carry up to 30% of the city's traffic. Not only this, there is also a nearby hospital which generates a lot of siren noise.

Planning consent was granted in July 2014 for the construction of a new retail and residential premises comprising of eleven flats and a small supermarket. Being in both a conservation area and built in accordance with Lifetime Homes, Code for Sustainable Homes and with the acoustic consultant dictating strict acoustic ratings, this was a carefully orchestrated build. To be successful the correct specification of the windows was imperative.

"The sound reduction properties of the windows were key in the realisation of this high-end development. Bereco made navigating through these strict requirements easy and the resulting sound reduction is quite extraordinary."

Director, Marbank Construction Limited

Despite heavy traffic, this is an upmarket area made up of 5-star hotels, boutiques, and Christie's; one of the most famous auction houses in the world. The area was once the residence of the late Diana, Princess of Wales prior to her engagement. As a high profile area surrounded by ornate buildings, it is important that new developments are not only high-end in both design and specification but that architectural sensitivity is employed in order to pay homage to this historically rich district.

Bereco sliding sash windows provided the perfect mix of design compatibility, high energy ratings needed to satisfy Code for Sustainable Homes and most importantly, a dB rating that surpassed the requirement.

With a glazing dB rating of 46dB, the overall window provides a rating of 42dB and a Bluesky A-rating. We were able to supply not only test evidence but, more importantly, certification to support the data, therefore offering complete clarity and assurance.

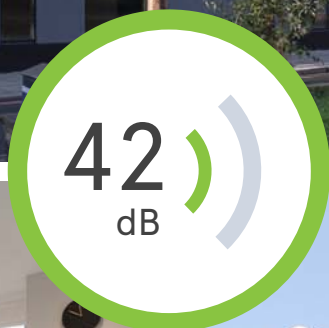

Sleep
SAFE & SOUND



Suburban Silence

The beautiful sliding sash windows not only shield the sound and create a haven of calm and wellbeing but they flood these modern apartments with natural light. The white painted internal finish promotes serenity whilst the grey painted exterior finished in Umbra Grey works perfectly with the heritage brick and stone façade that compliments the building's surroundings.

The scheme is now a local landmark overlooking one of the main arteries in and out of London but from the luxurious interior of the property the sound of the city is left behind allowing residents to enjoy the sound of silence.

.....
"The sound of silence is something which is hard to come by in the city. We have achieved this and much more with Bereco sliding sash windows."

Director, Marbank Construction Limited
.....

Noise reduction was a primary concern for both developer and client in the design of this new build family home in the suburbs of North London, which is situated facing a busy road.

Having acquired land in the popular suburban area of Totteridge the design concept was to create a high-specification six bedroom family home which embodied the style of a luxury city apartment but could be used as an escape. In order to encompass retreat-like characteristics, the client opted to undertake a road traffic noise assessment to determine what they would need to do to ensure a comfortable living space for their family.

The road traffic noise was found to have significant impact on the front elevation, in particular the bedrooms and dictated that measures to reduce internal noise levels should be taken. The developer, having used Bereco timber windows on a previous client build, knew that being bespoke and having good insulating properties Bereco would be able to find a solution to the desired specification.

A glazing dB rating of 39dB was stated in the report, however the client was concerned about the ability of the window to

.....
Project:
1 The Pastures

Location:
London, UK

Area: 539sqm
.....



perform and reduce dB levels when the whole window was taken into account. We were able to alleviate these issues with the ability to prove the performance of the whole window to 38dB Rw via independent testing. Not only this, the windows achieved a Bluesky acoustic B-rating.

Sash windows are traditionally chosen for their beautification of a property than their functionality and performance characteristics. Our Ambient sliding sash windows allow you to have both, meaning you don't have to choose between specification and design perfection.

The result is a beautifully finished luxury family home which embodies the charm of the city whilst a space that all the family can relax and enjoy.

.....

“We are very impressed with the windows and their ability to reduce noise in our front living rooms and bedrooms. Not only do they look beautiful but they offer us our peaceful retreat in London we dreamt of.”

.....

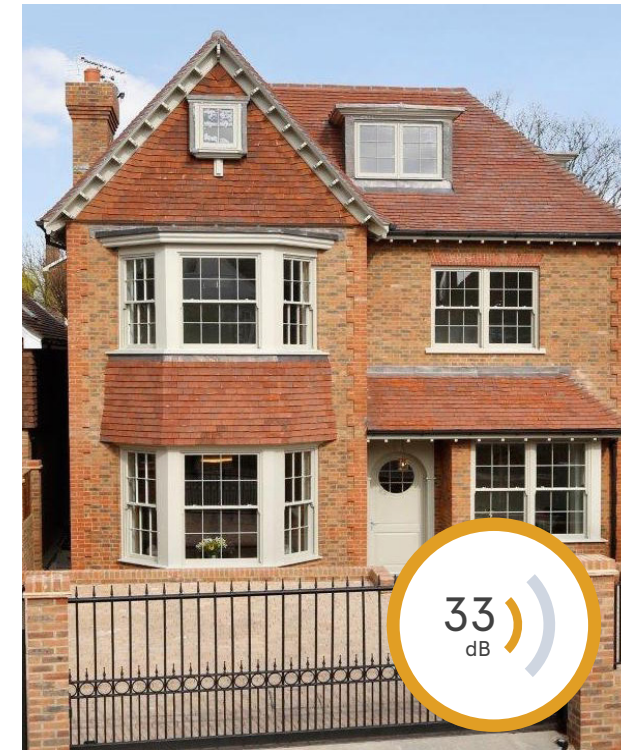
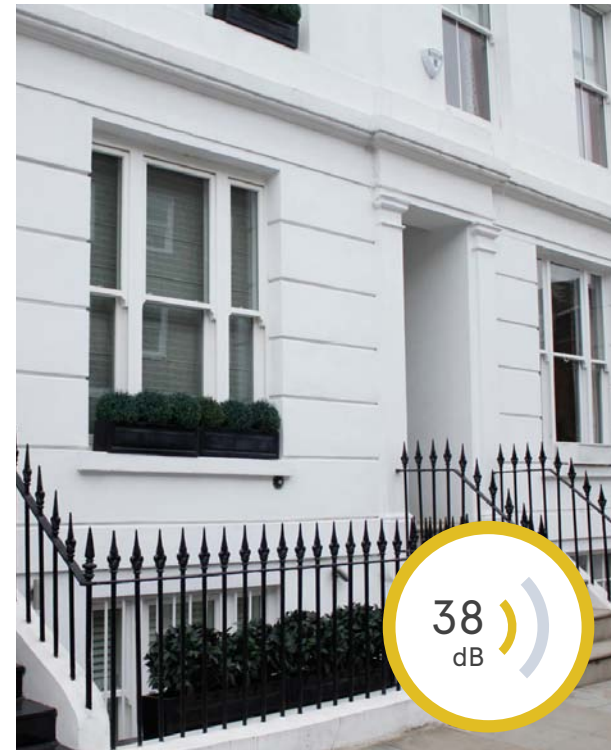

NOISE REDUCTION IN NEW HOMES

There is a great emphasis on building healthy homes. This centres on good indoor air quality, natural lighting and thermal comfort. Achieving acoustic comfort via sound reducing building products is absolutely crucial to this and the only way to achieve this is via the correct specification of the windows and doors.

As a member of The Alliance for Sustainable Building Products, we absolutely champion the movement to healthier happier homes and our Ambient Timber Window and Door Range has been designed with this concept in mind. The ASBP believe that the best buildings are life-enhancing and support our physical and mental health and we at Bereco work on this principle.

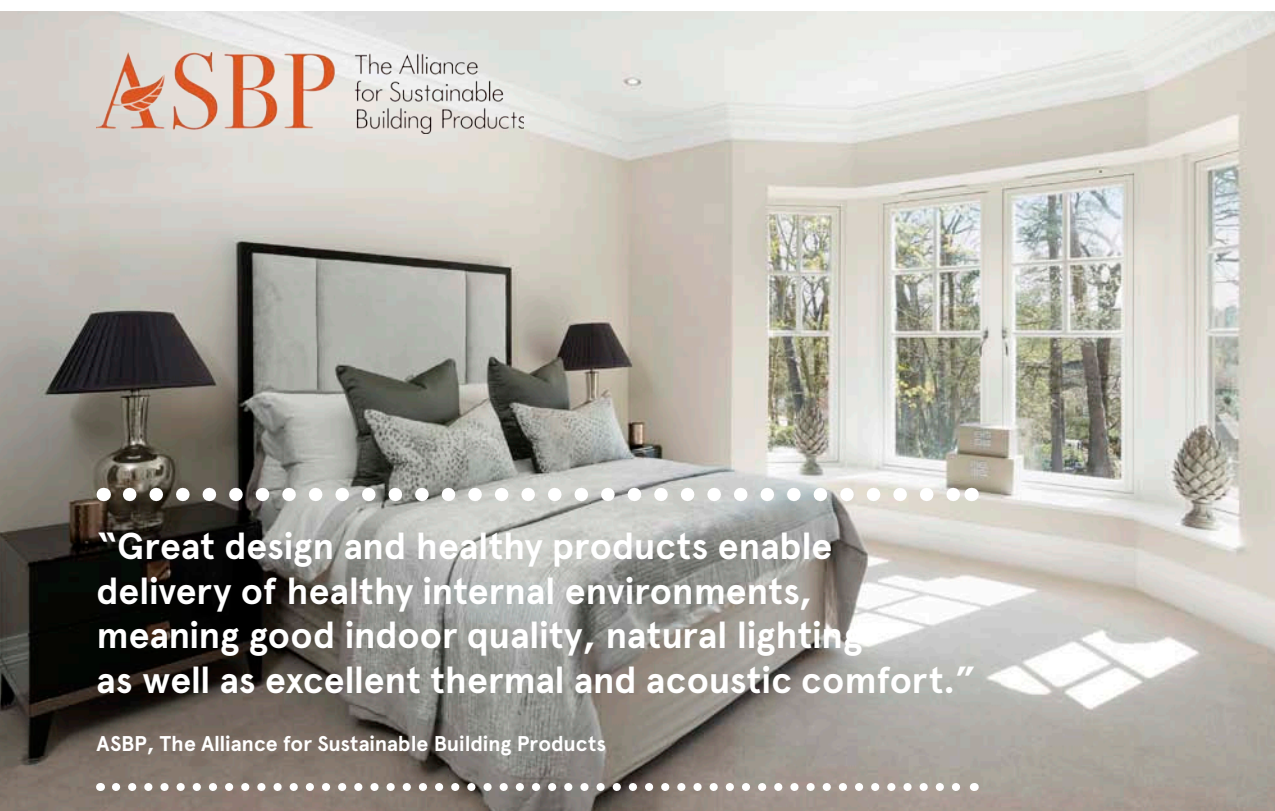

ASBP The Alliance for Sustainable Building Products

“Great design and healthy products enable delivery of healthy internal environments, meaning good indoor quality, natural lighting as well as excellent thermal and acoustic comfort.”



ASBP, The Alliance for Sustainable Building Products

HOW IS NOISE ADDRESSED?

If at planning stage noise is considered to be an issue, an assessment will be carried out to BS8233:2014 to measure the external noise. Calculations will be undertaken by an acoustic consultant in line with BS EN 12354-3 in order to determine the internal noise levels that will be present within the building. The calculations will need to determine that noise levels will be appropriate in order for the plans to be approved.

The window specification is a key item that will be addressed. The report will determine the frequencies of the expected noise source and stipulate a product that has a specific performance at these frequencies. As we have designed a range of options taking into account various noise sources and proximities we can help you find the most suitable and cost-effective solution to designing out noise.

HELPING YOU DESIGN OUT NOISE

- 
Let us Tackle the Detail
 Our experienced sales and design team will help you interpret your acoustic report and provide support at all stages including all the specification details you need to comply with the requirements detailed in your report.
- 
A Certified Solution to Provide Compliance with your Acoustic Report
 All noise reports are governed by BS8233: 2014 which represents government guidelines and compliance. The following internal noise levels are recommended as part of this. Purchasing a certified sound reduction solution means you have complete assurance that you will achieve compliance.

Description	BS8233: 2014 Desirable Internal Noise, LAeq (dB)
Daytime Noise (07:00 – 23:00) – Living Room	35 dB LAeq. 16hour
Daytime Noise (07:00 – 23:00) – Bedrooms	35 dB LAeq. 16hour
Daytime Noise (07:00 – 23:00) – Dining	40 dB LAeq. 16hour
Nighttime Noise (23:00 – 07:00) – Bedrooms	30 dB LAeq. 8hour

- 
Ease of Compliance with Part Q (Security)
 Part Q of the Building Regulations stipulates P1A-rated laminated glass. Bereco Ambient timber windows and doors come with P2 and P4 security ratings; better than the P1A required for Secured by Design and Part Q.





FAQ'S We answer some of your frequently asked noise reduction questions

Q How can I find out what the noise levels are inside my house?

A An acoustic specialist will be able to provide a full report of the noise levels in your home but as this can be costly this is usually produced for new homes and developments. If you want to have some idea of the level of noise in your home there are apps available that will measure the sound or could refer to page 07 to give you an idea of the level of noise you may be experiencing and whether or not this is harming your health.

Q The noise levels measured vary during night and day, does this matter?

A Our hearing system is complex. We have the ability to filter out background noise, yet our brain's fight or flight mechanism is prepared in response to noise that might be considered a threat in order to prepare us for action. This can happen while we sleep without us actually being aware of it. This means that noise levels, particularly at night if our fight of flight mechanism is repeatedly triggered can be damaging to our health.

Q What are the safe levels of background noise?

A The accepted levels of internal noise for residential premises are contained in British Standard 8233: 2014. These in turn were based upon the World Health Organisation recommendations 1999 "Environmental Health Criteria 12: Noise", which also stated: "..... a level of less than 30 dB is recommended to preserve the restorative process of sleep."

Q What kind of noise reduction can I expect with the Ambient Range?

A The dB ratings ranging from 33dB right up to 42dB represent the overall rating for the whole window taking into account both frame and glass. Broadly speaking, our standard double glazed unit performs at 33dB meaning that if you are experiencing road noise at 68dB this is reduced to approximately 35dB.

Q What affect do trickle vents have on window acoustic performance?

A Despite acoustic vents offering specific dB ratings, by inserting a trickle vent you are essentially drilling a hole in the window frame and therefore it is likely that this will allow some noise to 'leak' which will affect the overall dB rating for the window.

Q Will acoustic glass alone offer me the sound reduction I am looking for?

A If you were to fit the best acoustic glazing, this will be ineffective if elements of the surrounding frame still allow noise 'leaks'. Elements such as gaps in the frame and poor fitting gaskets will all allow noise to pass into the room and render the glazing ineffective.

Q How much of an effect do curtains or blinds have?

A Noise reduction curtains and blinds can be effective at reducing noise. However, if you do not assess the windows themselves in terms of their ability to reduce noise then this will prove ineffective.





01709 838 188
www.bereco.co.uk

Bereco Group
Units 4-5 Aspen Court
Centurion Business Park
Bessemer Way
S60 1FB

